

The marking on this product doesn't contain environmental hazardous materials per directive 2011/65/EU for RoHS compliance.

REVISIONS					
ECN NO.	REV.	DESCRIPTIONS	CHECKED	APPROVED	DATE
	AX1	INITIAL RELEASE	KOCHI	DAVID	11/07/2016
	AX2	ADD ZIP BAG	JUSTIN	KASUN	09/07/2017
	AX3	CHANGE PN OF CUSTOMER AND PACKAGE	JIESS	KASUN	06/19/2018

NOTE:  
 1. THE CABLE ASSEMBLY SHALL BE MEET R&HS2.0 COMPLIANT.  
 该产品通过RoHS2.0认证。  
 2. THE CABLE ASSEMBLY SHALL MEET BELOW IMPEDANCE REQUIREMENT:  
 TERMINATION AREA: 85±15% OHMS, CABLE ABSOLUTE AREA: 85±10% OHMS.  
 该产品满足下面阻抗特性: 接触区域85±15% 欧姆, 线材为85±10% 欧姆。  
 3. ELECTRICAL AND MECHANICAL PERFORMANCE SHOULD MEET THE SAS4.0 INDUSTRIAL STARDAND.  
 电气和机械特性遵循SAS4.0工业标准。

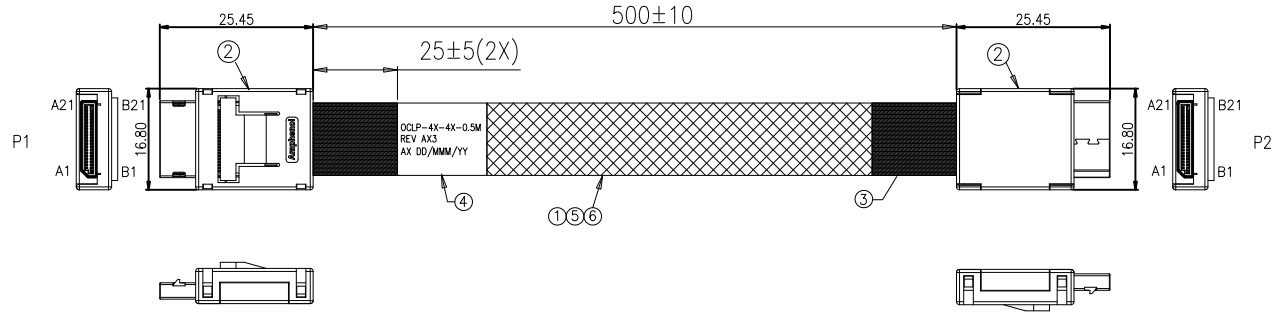

P1		P2	
A1	B1		
A2	B2		
A3	B3		
A4	B4		
A5	B5		
A6	B6		
A7	B7		
A8	B8		
A9	B9		
A10	B10		
A11	B11		
A12	B12		
A13	B13		
A14	B14		
A15	B15		
A16	B16		
A17	B17		
A18	B18		
A19	B19		
A20	B20		
A21	B21		
B1	A1		
B2	A2		
B3	A3		
B4	A4		
B5	A5		
B6	A6		
B7	A7		
B8	A8		
B9	A9		
B10	A10		
B11	A11		
B12	A12		
B13	A13		
B14	A14		
B15	A15		
B16	A16		
B17	A17		
B18	A18		
B19	A19		
B20	A20		
B21	A21		

WIRE TABLE

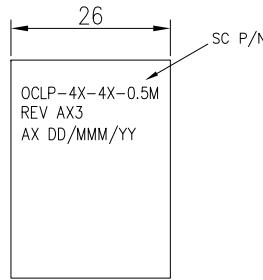

LABEL DETAIL

6	H03302300X	WIRE,30AWG,UL3302, 7/0.10,0D0.55,FR-XLPE,VW-1,NO MARKING,HF	A/R
5	HMTBD00501	EXPANDO TUBE:OD=5MM,BLACK,VW-1,HF	A/R
4	HMLSB57262	LABEL:57*26MM,BLANK,WHT,R2,HF	1
3	HMMTP00012	ACETATE TAPE:W=1INCH,HF	A/R
2	OCL42-0003	MiniLink,42POS,CONNECTOR, STR WITH ACTIVE LATCH	2
1	HWSS320020	SAS CBL:UL20744,32#2C+2C+A+HM,BLU,85Ω,VW-1,HF,24G	A/R
ITEM	P/N	DESCRIPTION	QTY

This drawing is the property of Serial Cables and is delivered on the express condition that it is not to be disclosed, reproduced or used, in whole or in part, for manufacture or sale by anyone other than Serial Cables without its prior consent, and that no right is granted to disclose or use any information in this drawing.



GENERAL TOLERANCES	
.X:	± 0.5
.XX:	± 0.3
.XXX:	± 0.01
ANGULAR:	± 1°

DRAWN:	NATHAN CAO	DATE:	06/19/2018
CHECKED:	JIESS HUANG	DATE:	06/19/2018
APPROVED:	KASUN LI	DATE:	06/19/2018

TITLE: SC P/N:OCLP-4X-4X-0.5M OCULINK 4X STR TO STR		
DWG. No.: RML42-0372		
SCALE: NONE	SHEET 1 OF 2	
UNIT: MM	SIZE: A4	REV.: AX3

The marking on this product doesn't contain environmental hazardous materials per directive 2011/65/EU for RoHS compliance.

REVISIONS					
ECN NO.	REV.	DESCRIPTIONS	CHECKED	APPROVED	DATE
	AX1	INITIAL RELEASE	KOCHI	DAVID	11/07/2016
	AX2	ADD ZIP BAG	JUSTIN	KASUN	09/07/2017
	AX3	CHANGE PN OF CUSTOMER AND PACKAGE	JIESS	KASUN	06/19/2018

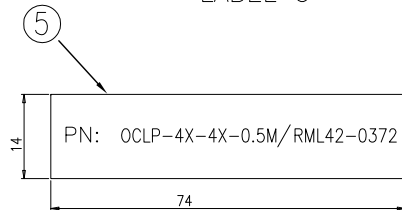
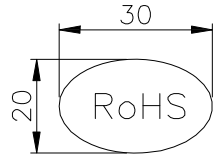
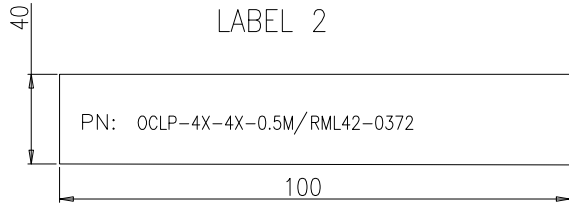

⑤ The label is stucked in the middle.

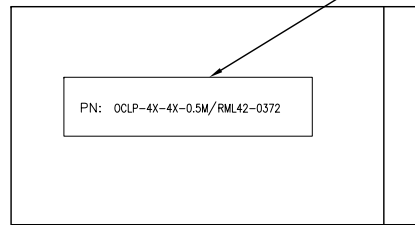

④ 1PCS PRODUCTS PUT INTO THE PE BAG

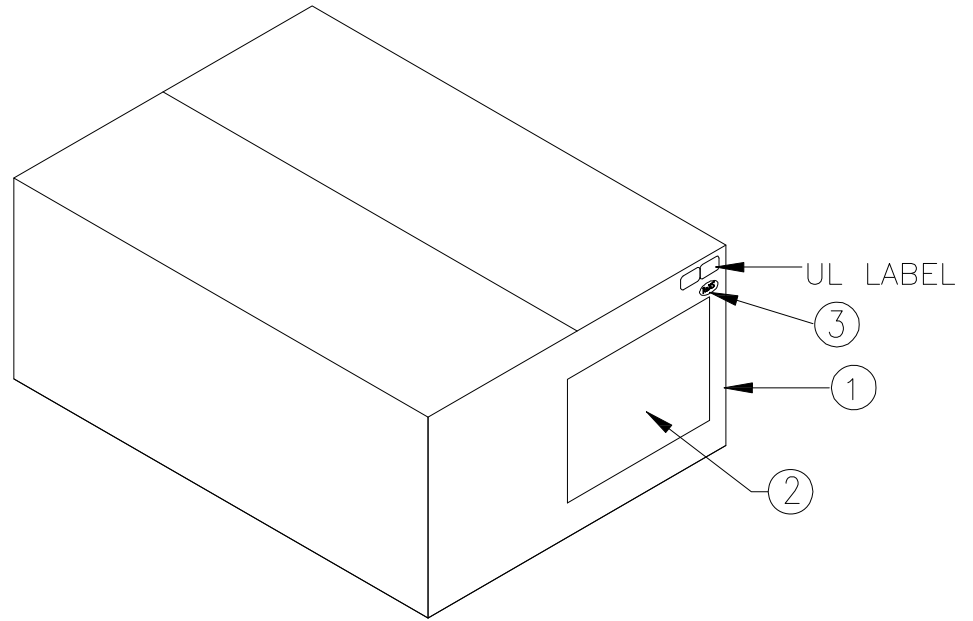

5	HMLSB14741	LABEL:Synthetic Paper,14*74MM,WHT,HF	1
4	RMBZIP0018	ZIP BAG:120*300MM,T=6C	1
3	RMLSW30201	RoHS LABEL:30*20MM, LABEL5 INFO	1
2	RMLSB00401	LABEL3:100*40MM,WHT,BLANK,R2	1
1	RMBCTN0019	CARTON:590*240*200MM E TYPE	1
ITEM	PART NUMBER	DESCRIPTION	Q'TY

This drawing is the property of Serial Cables and is delivered on the express condition that it is not to be disclosed, reproduced or used, in whole or in part, for manufacture or sale by anyone other than Serial Cables without its prior consent, and that no right is granted to disclose or use any information in this drawing.



GENERAL TOLERANCES

.X:	± 0.5
.XX:	± 0.3
.XXX:	± 0.01
ANGULAR:	± 1°

DRAWN:	NATHAN CAO	DATE:	06/19/2018
CHECKED:	JIESS HUANG	DATE:	06/19/2018
APPROVED:	KASUN LI	DATE:	06/19/2018

TITLE:		
SC P/N:OCLP-4X-4X-0.5M OCULINK 4X STR TO STR		
DWG. No.: RML42-0372		
	SCALE: NONE	SHEET 2 OF 2
UNIT: MM	SIZE: A4	REV.: AX3